

I

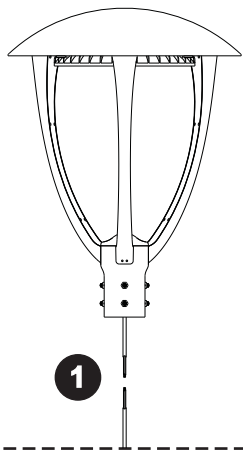

II

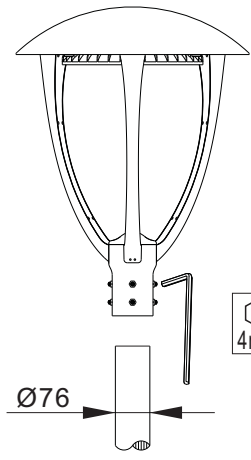
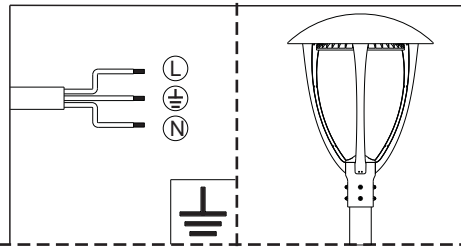

2

4mm 15Nm

III

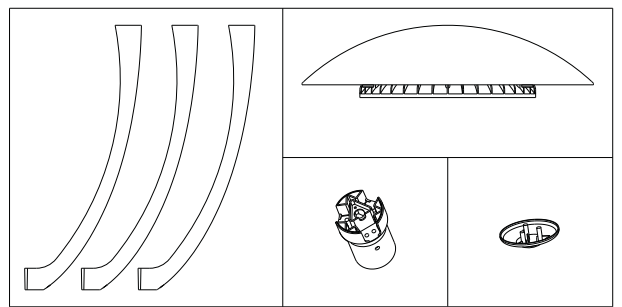

IV

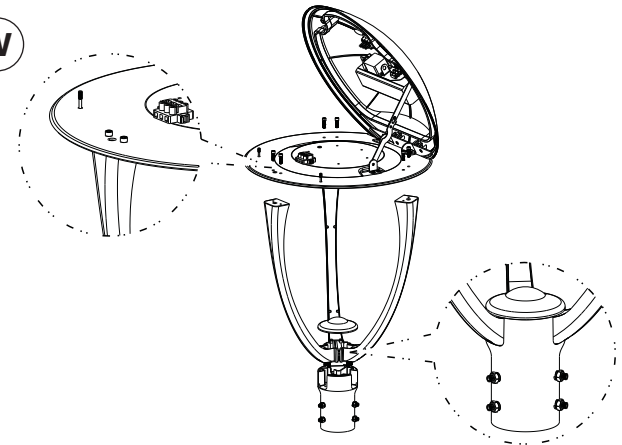

V

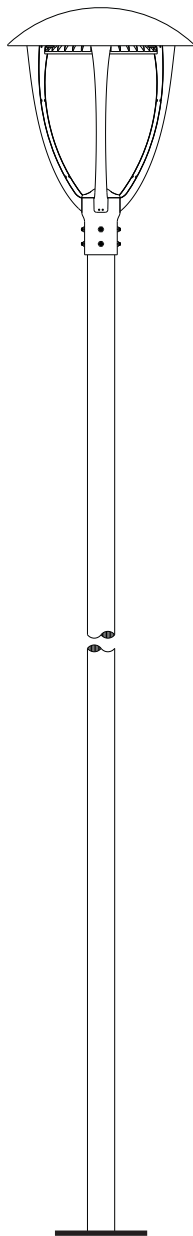
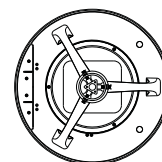
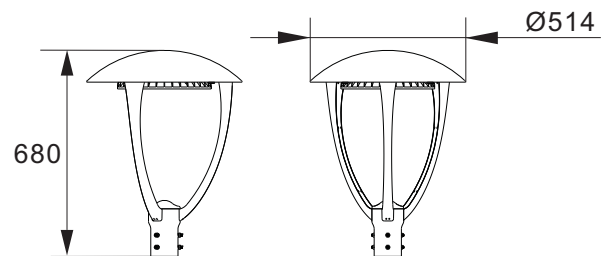

IK08

